

## Description

LPK is a range of compact in line duct fans. They benefit from very low profiles. The LPK 200 is only 20 mm higher than the duct diameter. This makes the LPK range an ideal choice where a low installed height is required. All fans are fitted with an external rotor motor whose bearings are sealed for life and a forward curved impeller for high performance and a very low sound level. Cleaning and maintenance are made easy with the swing out motor and impeller assembly.



## Technical data

Parameter	Value	Unit
Voltage	230	V
Phase	1	~
Frequency	50	Hz
Power	0.08	kW
Current	0.34	A
R.p.m.	1800	r/m
Max. temperature of transported air	50	°C
Max. temperature of transported air when speed-controlled	50	°C
Sound pressure level at 3 m	44	dB(A)
Length	350	mm
Width	272	mm
Height	122	mm
Weight	3.5	kg
Enclosure class, motor	44	IP
Insulation class, motor	F	
Capacitor	2	µF
Duct connection	ø100 mm	

Diagrams

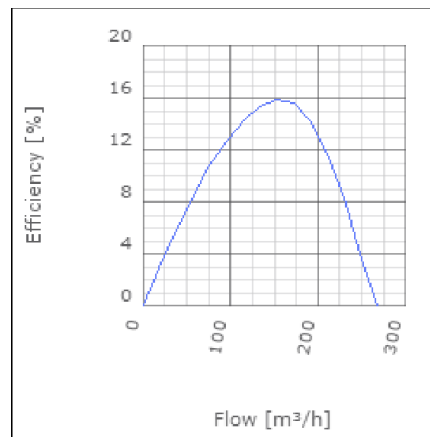
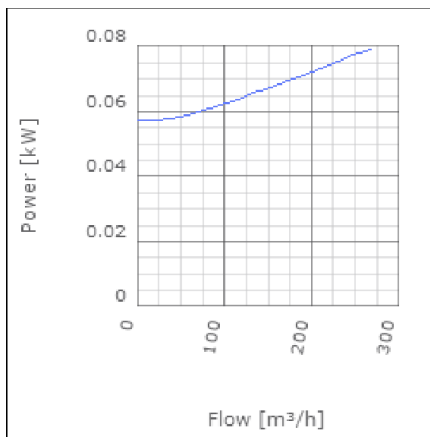
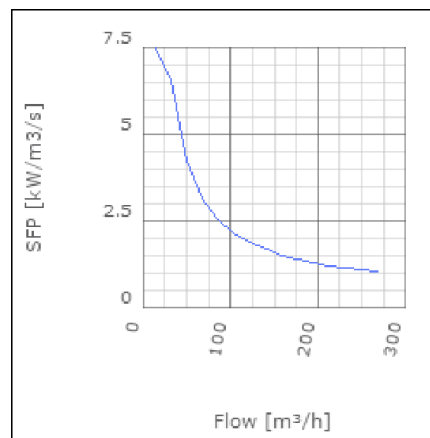
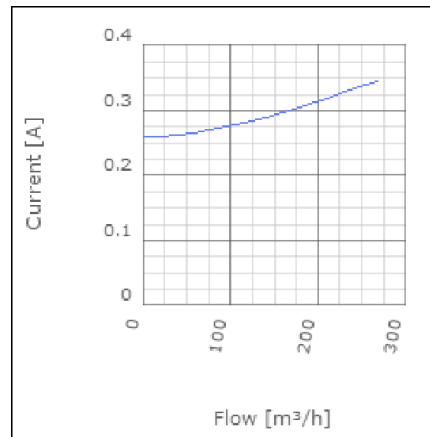
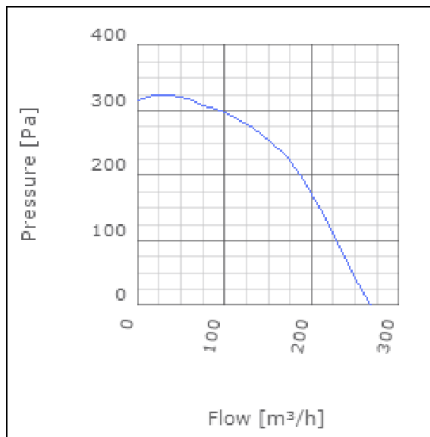

Sound

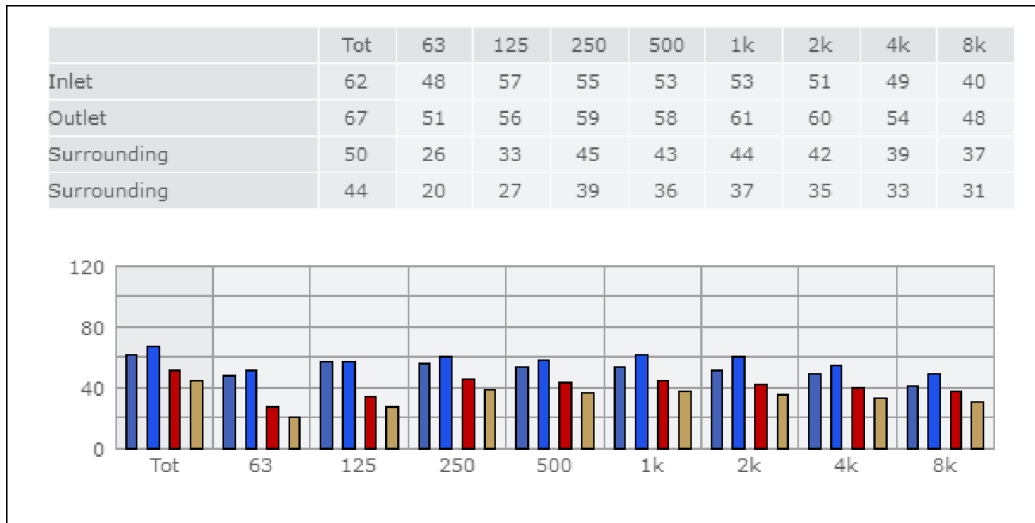

**Parameter**

Distance: 3.000  
 Propagation type: Hemi-spherical  
 Equivalent absorption area: 20.00

**Checked point**

Flow 163.309m<sup>3</sup>/h  
 Static pressure 235Pa

**Working point**

Flow 164.504m<sup>3</sup>/h  
 Static Pressure 238Pa  
 Power 0.07kW  
 Speed 0r/m  
 Current 0.3A  
 Voltage 230V  
 Efficiency 15.862%  
 SFP 0kW/m<sup>3</sup>/s

## Dimensions

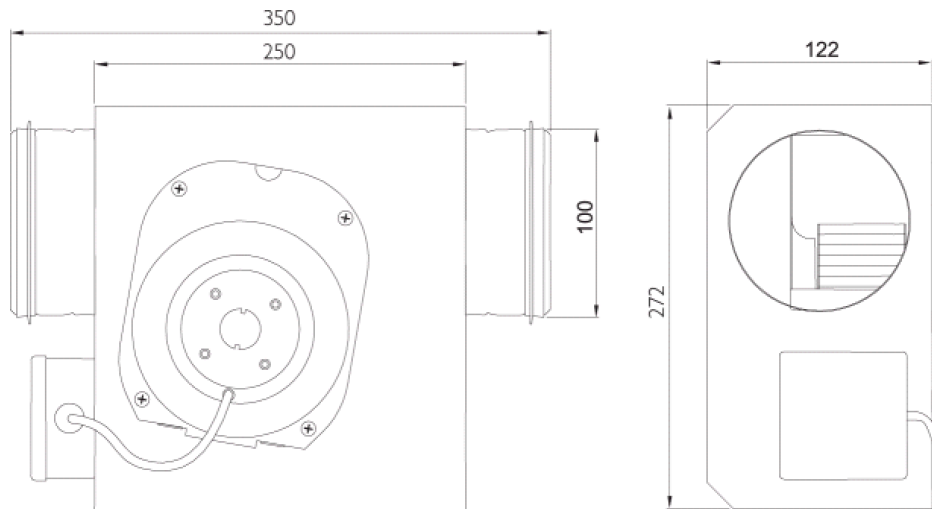

## Wiring diagram

4040001

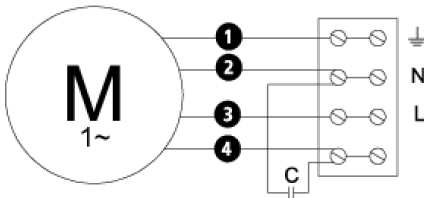

- Ⓜ = Fan Motor
- Ⓜ1 = Fan Motor
- Ⓜ2 = Fan Motor
- Ⓜ3 = Rotor Motor
- ① = Yellow/Green
- ② = Black
- ③ = Blue
- ④ = Brown
- ⑤ = White (TW)
- ⑥ = Orange
- ⑦ = Grey
- ⑧ = Red
- ⑨ = Green
- ⑩ = Violet

## Accessories

ETFV-94A  
FRE 6  
VRDE 1,5  
VRS 0,5  
VRTEC

## Electrical accessories

FLF 100  
FLK 100  
BSV 100  
YG 100  
LDC 100